



## 2019 FASTRAK NE SPORT MODS

(ALL RULES ARE SUBJECT TO CHANGE OR AMENDED BY FASTRAK OFFICIALS in the interest of fair competition)

**All changes/adjustments from previous year will be in RED.**

**Amendments to all rules during season will be in RED.**

### RULE BOOK DISCLAIMER

The rules and/or regulations set forth herein are designed to provide for the orderly conduct of racing events and to establish minimum acceptable requirements for such events. These rules shall govern the condition of all events, and by participating in these events, all participants are deemed to have complied with these rules.

**NO EXPRESSED OR IMPLIED WARRANTY OF SAFETY SHALL RESULT FROM PUBLICATION(S) OF OR COMPLIANCE WITH THESE RULES AND/OR REGULATIONS.**

They are intended as a guide for the conduct of the sport and are in no way a guarantee against injury or death to a participant, spectator, or official.

The race director/tech director shall be empowered to permit reasonable deviation from any of the specifications herein or impose any further restrictions that is in his/her opinion do not alter the acceptable minimum requirements and/or in the fairness of competition. **NO EXPRESS OR IMPLIED WARRANTY OF SAFETY SHALL RESULT FROM SUCH ALTERATION OR SPECIFICATIONS.** Any interpretation of deviation of these rules is left to the discretion of the officials and their decision is final.

All participants, fans, car owners, officials agree to a "hold harmless" contract by competing in or being present at a FASTRAK weekly or touring event. Should litigation of any decision or incident be required, all parties AGREE TO venue and JURISDICTION in Charlotte NC.

**"WE RESERVE THE RIGHT TO CHANGE THE RULES BASED ON THE "FAIRNESS OF COMPETITION"**

**Note: purse monies at Touring events are paid by the speedway hosting the event. In the case a track fails to pay, FASTRAK will work on behalf of the teams to collect their money. FASTRAK is not responsible for the purse. The SERIES PAYS BY CHECK THE NIGHT OF THE EVENT.**

**FIRST PLACE MONEY WILL BE HELD UNTIL TIRE SAMPLES COME BACK FROM THE LAB**

**MISSION STATEMENT:** *The company founder can relate to your needs. He drove for over 30 years and owned a team, owned a track and now a series. He's seen it from all sides in other words and we think this gives our company a unique "view" of things. He knows what it's like to race with very little money, having to borrow a truck and trailer, tools, parts and make the best of what he could afford. No different than when FASTRAK started, that first race on April 3<sup>rd</sup>, 2004, there were only 5 cars. Now the Tour pays \$10,000 to win the points, the National Weekly Championship pays \$10,000 to win and the World Championship pays \$50,000 to win. There is NO reason we cannot do the same for this class. Work with us and we will work with you.*

*Welcome to our racing family!*

### **CONTACT INFORMATION/CONTACT INFORMATION**

FASTRAK Companies International LLC

PO Box 590, Carnesville GA 30521

8077 Royston Road, Carnesville GA 30521

General Number: (678) 935-7304

Fax Number: Fax: (706)286-8432

Website: [www.fastrakaracing.com](http://www.fastrakaracing.com)

General Manager: DJ Irvine

Office ext 4

cell: (270) 564-1914

[dj@fastrakaracing.com](mailto:dj@fastrakaracing.com)

National Tech Director: Brad Hibbard

Race One

cell: (330) 540-7223

### **POINT FUND(S)**

To Be Announced

Winner will also be awarded trophy and leather jacket at the National Awards Banquet at year end

### **POINT SYSTEM**

35,34,33,32,31,30,29,28,27,26,25,24,23,22,21,20,19,18,17,16,15,14,13,12. Any position after 24th will receive 11 points. MUST TAKE THE GREEN FLAG UNDER "COMPETITION" to receive any points. This includes having legitimate mechanical

### **BONUS POINTS**

Bonus Points are based on car count maximum of 10 points. (5 cars 5 points, 6 cars 6 points etc) with maximum of 10 bonus points. All cars participating on any given night receive bonus points per position. Winner 35 plus with 8 cars 8 bonus points, 2<sup>nd</sup> 34 plus 8, though the field. Cars receiving 11 points will also receive the bonus points.

### **POINTS BEGIN**

1st race of any weekly sanctioned track, but not before April 1<sup>st</sup> with points ending September 1<sup>st</sup>

*Champion to be determined by best 15 finishes.*

In the event of a tie monies of the 2 positions will be added together and split equally.

Trophies and jackets to be awarded to both in the event of tie for 1<sup>st</sup> place to be announced as "co-champions".

Tracks may have (1) double feature night and award points for each in the case of multiple rain outs

### **MEMBERSHIP(S)**

Membership is \$100 annually which includes \$100,000 in "additional medical insurance" through Liberty Mutual.

Crew members, family members can be added for only \$20 each.

Drivers under the age of 16 may be required by insurance company to do a "driver test" before season begins

Only members are eligible for point monies – no points until membership is received

Non Members are required to fill out a non member form BEFORE competing in any event weekly or touring

### **SERIES SPONORS AND CONTNEGENCIES AWARDS:**

Sponsor decals and FASTRAK decals are mandatory on each car. Those sponsors may also award different contingencies throughout the year and also at the National Awards Banquet. Will be awarded based on sponsor requiremCONDUCT RULES

Track conduct rules apply at all weekly tracks and touring events

Fighting: \$500 fine, loss of point for that event and loss of monies - 2<sup>nd</sup> Offense \$1500 fine and loss of all points and eligibility of points monies and/or awards.

Social Media: Bashing of FASTRAK and/or weekly sanctioned tracks will result in 1<sup>st</sup> Offense \$500 fine- 2<sup>nd</sup> offense loss of all points for the season.

### **PROTEST**

Must state intent to protest to Official(s) before or as car is crossing scales

Complete engine protest \$1000 (\$250 to Official)

Complete engine tear down will be done at local authorized builder. Both parties must be there to witness tear down.

Pump engine \$150 (\$50 to Official)

Pull Head \$300 (\$100 to Official)

Check rear end \$400 (\$150 to Official)

Valve Spring Test (on engine) NO CHARGE

Valve Spring Bench Test @ Open Pressure \$150 (\$75 to Official)

Fuel Protest \$100 (\$50 to Official)

Tire Lab Test \$150

Ignition Box- \$250 (\$50 to Official)

### **PENALTIES**

Engine – barred or 365 days, loss of monies and points for event, \$1000 fine

Rear End- loss of monies and points for event, \$500 fine

Valve Springs- loss of points and monies for season, \$2000 fine, barred for 30 days, loss of championship monies

Fuel- loss of monies and points for event, \$500 fine

Tires- loss of monies and points for event, \$500 fine

Conduct- stated above

Ignition Box – loss of monies and points for year, \$500 fine

Headers – loss of monies and points, \$500 fine

(In all cases illegal parts will be confiscated and destroyed by Officials)

(Not allowing Official to perform protest, in full, will result in fine and other penalties pertaining to the part)

All fines, penalties must be paid or performed in full before returning to competition

Appeals: All appeals must be in writing with full explanation of reason for appeal within 48 hours of incident. Appeal will be heard on first possible occasion of Officials. May be in person or by skype video conference. Person appealing is 100% responsible for all fees of appeal including but not limited to Attorneys fees. Any appeal not received within 48 hours of incident will not be heard and loses all rights of the appeal process.

Fax: (706) 286-8432      email: office@fastrakracing.com

### **RADIOS/RACEIVERS**

Two way communications are not permitted at any time.

Raceiver is mandatory at all times (always put in a fresh battery)

Go Pro cameras allowed (for filming purposes only)

### **ELECTRONICS**

No traction control devices wired, molded, GPS, inside the box or otherwise permitted.

No driver controlled wheel spin devices

No timing devices

No fuel control devices

No remote control devices on any type

No data acquisition devices

## **DRIVER SAFETY**

Must have SFI, FIA, Snell rated helmet within 5 years of current rating(s) (NO DOT Helmets)

Must have 5 point seat belt system of racing type no more than 2 years old

Must have fire retardant or fireproof gloves, boots and fireproof suit minimum of 2 layer.

Head and Neck restraint strongly recommended

Roll bar padding mandatory. Must be fire resistant

Automatic fire system strongly recommended

Minimum 20 lb fire extinguisher in competitor's trailer mandatory

System Cut off switch within drivers reach and easily accessible to Officials from outside car mandatory

Battery must be mounted securely and fully enclosed in marine style box (plastic ok)

Must have driveline U Joint scatter shield

## **ENGINE**

Chevrolet Performance 602 engines only.

All engines are to remain as from factory including, but not limited to valve springs, harmonic balancers, etc with NO ALTERATIONS

Seals- factory seals, FASTRAK seals, all "series" seals are legal – FASTRAK rebuilders can only do "repairs" not rebuilds.

No dry sump, No external oil pumps, no vacuum pumps, no evacuation systems, no accu sumps permitted.

Oil cooler permitted (may not act as evacuation system)

Repairs must be by a SERIES authorized repair shop.

Must be approved by FASTRAK office before repairing.

Engine builder must sent request in on builder letterhead with serial number of engine, competitor name, reason for repair and exactly what is being repaired.

## **IGNITION**

Stock GM distributor only

NO crank trigger or what may be considered such

"Soft Touch Box" set at maximum RPM of 6300. Must remain as from factory. MSD Part Number- #8727CT.

No adjustments allowed from inside cockpit

Stock firing order only

## **CARBURETOR**

Holley 650 CFM Types: 4777 – 80777 or 4150 part # 0-80541-1

Carb must check "gauge legal" at all times including "hot"

Modifications allowed: squirters, power valve, air bleeds, jets, pump cams

Rollover Plate strongly recommended - Willys part number: PN-4000

No nitrous or other performance items may be added.

Carb Spacer may not be over one inch MAXIMUM – NO TOLERANCE (personally measure for verification)

Carb spacer may not protrude down into intake at any point

One gasket per surface – Maximum .070 thickness per gasket

## **COOLING SYSTEM**

One radiator only

Cast Iron Water Pumps only

Radiator may be of Aluminum of style type metal only

Must have a fan at all times. Fan may be of carbon fiber, metal or plastic

No electric fans permitted

## **CHASSIS**

The minimum wheel base is 106"-inches and a maximum of 110"-inches with a maximum tolerance of ½", when measured from the centerline of the rear axle to the centerline of the front axle for both left and right sides.

All frames must be fabricated utilizing 2"x4" rectangular magnetic steel tubing with a .120" wall thickness. Only 2"x4" rectangular box frames between the front and rear axle centers will be permitted. The 4"-inch side of the rectangular tubing must remain in the vertical position. For the purpose of inspection one 3/16" diameter hole may be drilled in each frame rail. Other holes will not be permitted. Round tubing must be either 1-1/2" outside diameter and/or 1-3/4" outside diameter with wall thickness of .095"-inches.

Frame width will be as follows; At the front shock towers a minimum 24" and a maximum of 35"-inches. Rear of the car is a minimum of 26" with a maximum of 35"-inches. The minimum frame width at the rear roll bar must be 26"-inches. All measurements will be taken from the outside of the frame rails, at the top and bottom of the frame rails and its longest length. Clips, sub-frames, etc., will be considered a part of the frame.

The minimum length of the 2"x4" frame rails begins 14"-inches in front of the centerline of the rear axle and extends to the front of the radiator. The left and right rails (both top and bottom) must be equal in distance from the driveline centerline along the total length of the frame. Offset frame rails will not be permitted. A maximum 4"-inch indent in the lower left rear frame rail for suspension clearance will be permitted. The two (2) upper frame rails in the engine compartment may be altered for engine clearance only.

The kick-ups must meet the same specifications as the roll cage and/or frame material.

Titanium and/or carbon fiber material(s) will not be permitted on the chassis and/or frame.

There must be a minimum of 2-1/2"-inches ground clearance from the chassis at its lowest point.

Ground effects will not be permitted.

## **ROLL CAGE**

Only round magnetic steel tubing 1-1/2" and/or 1-3/4" in outside diameter with a material thickness of 1-3/4"-.095"-inches and/or 1-1/2"-.120"-inches will be permitted.

The roll cage must be an integral and structural part of the frame. All frames built in 2005 and after must have a manufacturer's unique serial number plate visible and positively fastened on the left front roll cage upright. The letters and/or numbers shall not exceed 8 digits and be ½"-inch in height. See drawing 4.7.2

Front and rear roll bars must be positively fastened in a cage-type configuration. Two (2) round horizontal side bars on each side are required. The top side bar must be a maximum of 22"-inches below the top roll bar.

Proper bracing and triangulation on the front and rear roll bars is required. All roll bar bracing material must be 1-1/2"-inches outside diameter with a material wall thickness of .095"-inches. A minimum of one (1) diagonal bar across the top of the roll cage is required.

The rear main roll bar hoop must be a minimum of 26"-inches when measured across the outside-to-outside of the hoop and maintain that measurement from the top to the bottom of the cage. The bottom of the rear main roll bar hoop must be positively fastened (welded) to the 2"x4" frame rails. Outriggers will not be permitted.

The front roll bar hoop must be a minimum of 26"-inches when measured across the outside-to-outside of the hoop and maintain that measurement from the top to the bottom of the cage, with the exception of the allowable frame taper. Outriggers will not be permitted. Refer to the drawing in the back of this rule book.

**MANDATORY Frame/Roll Cage:** A piece of tubing, a minimum of 1-1/4" in outside diameter and .095"-inches in thickness, must be installed vertically and must extend through the car into the bottom frame rail or extend back to the union at the top of the door and rear main hoop joint. The tubing must be installed in a manner that does not impede the driver exiting the cockpit. The tubing must be mounted a minimum of 9"-inches and a maximum of 12"-inches on the roof bar from the existing rear roll cage hoop. This must be installed symmetrically on both sides of the roll cage. Existing cars must be retrofitted with this piece of tubing.

## **TRANSMISSION/DRIVELINE**

Manual standard transmissions only as considered the "industry standard" manufactured in the US or Canada.

Overdrives or under drives are not permitted

Must have "working" forward, reverse and neutral gears.

Reduction gears not permitted

Must be mounted to bell housing or originally intended from factory

Driveshaft Maximum of (2) U joints and or yokes- steel only

Driveshaft must be painted white with car number (safety issue)

Titanium gears or those of other exotic materials not allowed

- A maximum of two (2) universal joints per driveline

## **REAR END**

Only Quick Change type rear ends will be permitted.

No Hypoid-type or 9 inch ford rear ends

No lockers permitted

Only aluminum or magnetic steel spools will be permitted.

Only steel or aluminum rear spindles will be permitted. If the rear spindle is machined from aluminum it must be a one-piece tube and spindle with a minimum outside diameter 2-7/8" and a maximum 2-1/2" inside diameter.

Live rear ends with aluminum tubes will be permitted. All others must be approved.

Exotic materials not permitted.

Tungsten not permitted

A maximum rear end offset of 4"-inches from the center of the inside tire width when measured from the inside of the left rear tire to the inside of the right rear tire at axle height

Aluminum rear end tubes only, with a maximum wall thickness of .410". Outer diameter cannot exceed 3".

Outer collars other than to attach bridge cage are not permitted.

Excessively thick or enlarged brackets are not permitted. All brackets must be aluminum.

Drive Axles must not exceed 1.600" diameter and must be made of steel only.

Axle inserts not permitted

Maximum hub weight 10 lbs

Ballast inside of or attached to hubs not permitted

## **REAR SUSPENSION & RADIUS RODS**

The only materials used to fabricate attaching (radius) rods that will be permitted are magnetic steel or aluminum

Aluminum attaching (radius) rods may be solid or tubular material. Magnetic steel attaching (radius rods) must be tubular with a maximum wall thickness of 3/16 inch

## **FUEL SYSTEM/FUEL CELL/FUEL**

Only 93 octane or lower "pump gas" permitted. Fuel is subject to be checked at all times.

Gas can now be checked at the track digitally 95 octane maximum with allowance for temperature differences

No additives are permitted including but not limited to propane's, ethane's, nitro, propylene.

Mechanical fuel pump located in stock location only

No regulating devices of any type

Fuel cell maximum 24 gallon

Foam must remain in fuel cell as from manufacturer

Cell must be securely mounted inside metal container

Container must fit cell as recommended from factory

Must have metal or aluminum plate mounted on underside of container of .090 thickness

Plate must have (1) inspection hole for Officials inspection. No other holes allowed.

Must have 1"x1" rack made of .065 angle steel encasing outer edges of container

Penalties- 1<sup>st</sup> offense loss of monies and points and \$500 fine

2<sup>nd</sup> offense loss of any championship monies, event monies and all points for the year \$2500 fine

3<sup>rd</sup> offense banned for 365 days, \$5000 fine

## **EXHAUST**

Must have (1) unaltered muffler per exhaust

Must exit past driver with exhaust flowing toward rear of car upward away from racing surface

Each muffler must have a tail pipe that is a minimum of 10"-inches long when measured off the rear edge of the muffler

Cross-over and/or the joining of exhaust systems from side-to-side will not be permitted.

No merge collectors

No TRI-Y, step headers, coated headers permitted.

The header collector extension pipe and tail pipe must be inserted past the muffler inlet or outlet flange and must exit behind the driver. *Any other extensions and or add on components will not be permitted.*

Exhaust system must be completely sealed

Evacuation system not permitted

## **WEIGHT- BALLAST**

Minimum weight of 2450 after any part of the event.

All weight Must be mounted to frame below decking

One grade 5 bolt per 25 lbs of weight. Must be cotter pinned, or double locked nuts

Weight must be painted white with car number

Lost weight may not be added on scales

## **BODIES**

Maximum spoiler height 50 inches (w driver in car)

Magnetic steel or aluminum bodies only

Plastic or rubber material maximum of 8 inches allowed on quarter panels. May overlap 2 inches for attaching.

Doors must maintain a minimum of 6 inches ground clearance

Only clear lexan will be permitted for the rear spoiler and rear wing windows. Decals and/or lettering will not be permitted on the rear spoiler and or rear wing windows.

A full magnetic steel windscreen and/or rock guard is required.

The windscreen and or rock guard must have an individual hope opening of 2" x 1" with a minimum of 1/16" thickness.

Chicken wire type and or aluminum screens will not be permitted.

The windscreen and/or rock guard must cover the entire windshield area across the front of the roll cage and from the top of the roll cage down to the base of the cowl and/or hood.

In addition clear lexan-type and or safety glass windshields will be permitted. If the lexan and or safety glass is utilized it must be shatterproof and mounted behind the windscreen and/or rock guard.

Any additional windshield must not obstruct the driver's exit of the vehicle.

Only magnetic steel and/or aluminum will be permitted for all inner and outer body panels.

Offset bodies are not permitted.

## **ROOF**

A one-piece fiberglass roof or plastic roof only. Plastic carbon fiber "look" is permitted but not true carbon fiber.

Must weight a minimum of 10 lbs.

All roll bars must remain exposed.

The roof must be centered from side-to-side on the roll cage and on the frame.

Offset bodies are not permitted.

The leading edge of the roof must be positively fastened in a stationary position

Roof minimum of 33"-inches and a maximum of 48"-inches in front of the rear axle centerline.

Must be securely fastened on all sides. Minimum length of the roof is 48"-inches with a maximum of 60"-inches.

Minimum width of the roof is 48"-inches with a maximum of 52"-inches.

Must be of the turtleback style and shape with a minimum of ¾"-inche belly from front-to-rear and ¾"-inch from side-to-side.

The roof -contour must fit all series roof template patterns.

Flat roofs will not be permitted.

Maximum front lip ½"-inch. Maximum side edge(s) 1-1/8"-inch break.

Changes to the shape and/or location of the roof at any time during competition will not be permitted.

Maximum roof angle of 5 degrees

Maximum overall height of the car is 62"-inches with a minimum of 53"-inches measured from the ground.

Any proposed roof design that deviates from the preceding rules must be submitted for approval.

### **FRONT DOOR POSTS**

Must be (1) piece magnetic steel and/or aluminum front door posts and/or 'A'-pillars

Minimum of .050"-inches with a maximum of .090"-inches will be permitted.

The front door posts must be securely mounted the roof and to the door(s).

The side of the front door post must measure a maximum of 2"-inches.

The front door post may be bead rolled and/or have a lip and/or flange for re-enforcement max 3/8ths inch

The door post may be fastened with a minimum of two (2) 3/16"-inch bolts to the door bracket for ease of fabrication.

Additional material, air directional devices, lexan vent windows and/or excessive material will not be permitted in the corner of the front door post, where the post meets the door panel. Any additional material, air directional devices and/or vent windows must be a maximum of 10"-inches in length.

There will be no tolerance on the front door post measurements.

### **REAR WING WINDOWS**

All rear wing panels and windows must resemble a current production OEM style body. Only manufacture approved rear wing panels and windows will be permitted for competition. Any non-manufacture rear wing panel must resemble and/or meet the criteria as the submitted rear wing panels and/or windows. Any rear wing panel that is submitted for competition must not exceed 815 square-inches in total area. ***All rear wing panels must be submitted for approval prior to introduction into competition.***

The upper profile must not extend above a straight line projected from the rear of the roof to a point 3"-inches higher than the rear deck. A minimum 2"-inch indent in the profile, so as not to make the panel a fast back is mandatory. (Please refer to the drawing and photographs)

The maximum base length will be 61"-inches. The left and right must be of the same style and dimensions (symmetrical). (See example of Body Style Drawing)

All rear wing(s) must have an opera-type window. The window may be lexan, or a decal that resembles an opera-type window can be utilized. No lettering will be permitted on the rear wing panel. Bends or breaks in the lexan or decal area of the window will not be permitted.

Only one break as a change in body line/contour will be permitted in the rear wing panel.

The rear view of the wing window must go in a straight line from the top of the quarter panel (tangent) or bodyline to the roof with a maximum gradual bow of 2"-inches in the center of the wing window.

Flanges and or additional material added to the rear wing panel for the purpose of directing air flow will not be permitted.

### **BODY WIDTH AND CLEARANCE**

The body width, when measured at any point along the body line from front-to-back will be a maximum of 68"-inches and a minimum of 64"-inches.

A minimum chassis ground clearance of 2 ½"-inches will be permitted.

Fan and/or ground-effect cars will not be permitted.

Rubber skirts, fins, air directional devices and/or spoilers of any type under the car will not be permitted.

A 2"-inch maximum air deflector in front of the radiator for engine cooling will be permitted.



## **DOOR PANELS**

The side door panel(s) maximum of 85" inches and a minimum of 60"-inches in front of the centerline of the rear axle. The door(s), front door extensions and rear quarter panels must be flat mounted in a vertical position. They must remain flat. Flanges at a 90 degree angle may be added to the front of the doors. The flange may only be added for the purpose of strengthening the door material. The flange must not exceed ¾"-inch in length or width and must be mounted in a vertical position. Door flanges must face inward toward the centerline of the chassis.

Louvers, bead rolls holes and/or protrusions from top-to-bottom will not be permitted. Holes will be permitted for rub rails/nerf bars. A maximum 1"-inch long lip/flange at a 45 degree outward angle ½"-inch away from the sheet metal for reinforcement will be permitted at the top and bottom of the door(s) panels.

All outside sheet metal, door panels, door extensions, air dams, front nose and/or hood fins must be the same shape, size and angle on both sides of the car. The door(s) must match each other from side-to-side (symmetrical).

Air directional devices and/or side mounted spoilers of any type, which extend past the outside edge of the flat plane of the body will not be permitted.

Bead rolls around the outside perimeter of the door panels and the wing windows will be allowed. Bead rolled edges must face toward the center of the chassis.

The front door(s) extensions will be a maximum of 20"-inches behind the front axle centerline.

The top front corner of the door when measured from the ground will be a maximum of 38" and a minimum of 30"-inches when measured 60"-inches from the rear axle centerline.

The rear of the door when measured from the ground will be a maximum of 42"- inches to the top of the door when measured 16"-inches from the center of the rear axle centerline of the rear forward.

The ground clearance on the bottom of the doors must maintain a maximum of 12"-inches and a minimum of 6"-inches from the ground.

A maximum lip and/or flange of 1-1/2"-inches rounded at 90 degrees and facing inward only, on the top and bottom door(s) and rear quarter panel(s) will be permitted.

A lip and/or flange angled out at a maximum angle of 45 degrees, extending away from the door at a maximum of ½"-inch and a maximum of 1"-inch in length before it bends inward for strength at the top of the door(s) and/or rear quarter panel(s) will be permitted.

## **REAR QUARTER PANELS**

The rear quarter panels must be symmetrical in height, with or without plastic

The rear quarter panels must be a maximum of 47"-inches and a minimum of 40"-inches from the ground at the rear and continue in a straight line with the top of the door. (See drawing.).

A maximum 2"-inch fender flare may be used, but the overall body width must maintain a maximum of 68"-inches

The rear quarter panels may extend rearward a maximum of 48"-inches at the top and a minimum of 44"-inches at the bottom when measured from the center of the rear axle to the rear of the car.

A maximum of 16"-inches and a minimum of 8"-inches of ground clearance (when measured from the ground to the bottom of the rear quarter) will be permitted.

The plastic or rubber material utilized on the rear of the car may extend a maximum of 16"-inches from the ground to a minimum of 8"-inches from the ground on either side of the car (symmetrical). The panels may have one side plastic on one (1) side only provided the panel remains completely symmetrical.

Flanges at a 90 degree angle may be added to the Rear Quarter Panels. The flange may only be added for the purpose of strengthening the Rear Quarter Panel. The flange must not exceed ¾"-inch in length or width and must be mounted in a vertical position. Rear Quarter Panel flanges must face inward toward the centerline of the chassis. Air directional devices or side mounted spoilers of any type, which extend past the outside edge of the flat plane of the body will not be permitted.

## **REAR DECK**

The maximum height the rear deck when measured from the ground will be 47"-inches and a minimum of 40"-inches.

The rear deck lid must be fully enclosed from side-to-side and have a maximum height of 14"-inches and a minimum 9"-inches, vertically behind the fuel tank.

The left and right rear trunk lids must be symmetrical in size and shape and must remain flat to cover the fuel filler hose and apparatus. The panel must completely cover the fuel cell, the fuel filler hoses and the vent lines.

The fuel tank must be completely enclosed from the bottom of this panel to the bottom of the fuel cell.

The fuel cell must have both sides completely covered in sheet metal in addition the container it is enclosed in. Openings of any type will not be permitted.

Openings from the top of the fuel cell to the bottom of the trunk lid will not be permitted.

All vent line nozzles used for the purpose of a catch- can must be mounted on the left side of the quarter panel.

### **HOOD, NOSE, FRONT SPOILER**

The maximum width for the hood, nose and front spoiler will be 36"-inches with a minimum width of 24"-inches. Louvers will be permitted on the sides and top of the hood for cooling purposes only.

The nose-piece must not extend rearward of the front shock towers.

The front spoiler must be a separate piece.

Shock absorber covers and/or deflectors must not be a part of the nose or the spoiler and/or positively fastened to the nose in any fashion exceeding the 36"-inch maximum width.

Fabric material shock absorber covers will be permitted. The covers must not be used to achieve any aerodynamic advantage and/or to deflect air in a positive manner.

The maximum the spoiler may extend in front of the front axle centerline will be 20"-inches.

The front spoiler must be non-adjustable (hinges and/or sliders will not be permitted).

The hood shall be considered from the front roll cage to on top and in-line with the front of the radiator.

The hood and nose may have a maximum lip and/or flange of 2"-inches on both side following the contour of the body. They must remain symmetrical.

The hood and nose be centered on the centerline of the frame.

The hood, nose and/or spoiler must not overlap each other's location on the frame.

Any part of the hood must not exceed 10 degrees and the sheet metal must not have an opening and/or extrusion between the hood and the nose.

The hood must extend over the radiator and have complete sides.

The front spoiler may have a lip and/or flange a maximum 2"-inches on both sides following the contour of the spoiler not exceeding the maximum width of 36"-inches. The front spoiler may be offset 1"-inch from the centerline of the frame to the right or the left. One 2" high wicker bill may be added horizontally to spoiler in front of shock towers.

### **HOOD SCOOP**

The hood must be fully enclosed.

There are two (2) of hood scoops that can be mounted on top of the hood for the purpose of enclosing the carburetor and/or ram air. Ram Air will be permitted providing they meet the following specifications in this section.

The ram air scoop: A maximum 30"-inch length when measured from the rear motor plate to the front of the hood scoop will be permitted. A maximum width of 18"-inches will be permitted. The maximum 6"-inch front vertical opening at the beginning of the scoop will be permitted. A minimum of 8"-inches will be required from the highest point on the hood scoop to the lowest point on the front of the front of the roll cage and/or the roof. The hood scoop must be positively fastened to the hood and completely enclose the carburetor and the air filter.

The conventional air scoop (non-ram air): A maximum of 25"-inches is permitted from the center of the carburetor forward to the end of the hood scoop. A maximum width of 22"-inches will be permitted. A minimum of 8"-inches will be required from the highest point on the hood scoop to the lowest point on the front of the front of the roll cage and/or the roof. The hood scoop must be positively fastened to the hood and completely enclose the carburetor and the air filter

### **INTERIOR SHEET METAL**

All horizontal body support(s) other than the inner pods, whether in the front and/or rear must be a minimum of 1" x 1" .095"-inch thick tubing or 1"-inch flat stock a minimum of .125"-inch thick..

Inside and/or outside wings, spoilers, air foils and/or wind deflectors will not be permitted.

Double panels and/or sheet metal that is designed to create a wing effect will not be permitted.

A maximum 1"-inch reinforced flange will be permitted on all lexan, however, all specified measurements must be retained. All interior sheet metal must completely cover all interior areas, door-to-door, quarter panel-to-quarter panel. Holes and/or openings will not be permitted in this area.

Front and rear firewalls are required. The front firewall must isolate the cockpit from the engine compartment. The rear

firewall must extend from the top of the fuel cell to the belly pan to isolate the cockpit from the fuel cell. The firewall must be a minimum of .050"-inch thick aluminum and/or magnetic steel. The firewall may be altered and/or cut for drive shaft clearance. Vertical fins, air dams and/or fairings on either side, behind the roll cage will not be permitted.

All sheet metal must be a flat single plane across the interior of the car. Two (2) bead rolls or breaks for the purpose of strengthening and maintaining the shape of the wing will be permitted. The maximum bead roll and/or break permitted will be 1/8"-inch in height and 1/2"-inch in width.

Covered roll bars will not be permitted. Sheet metal that is one-piece and/or part of a body panel formed around tubing that is not considered an aerodynamic advantage will be permitted, provided there is no excess sheet metal.

Louvers will be permitted for cooling purposes only, including the radiator, engine and/or a working oil cooler. Louvers and/or holes in the interior or exterior sheet metal will not be permitted.

The floor and/or belly-pan may not be any wider than the frame at any point. Lips, fins and/or air directional devices on the floor and/or belly pan will not be permitted. The under pan must not extend in length past the rear of the seat and exceed the width of the frame rails of the car and must be a maximum of .090"-inches in material thickness.

Only aluminum belly pans will be permitted. Louvers for the purpose of cooling will be permitted on the belly pan from the radiator to the firewall. Panels under the rear and and/or the fuel tank will not be permitted.

### **DRIVERS COMPARTMENT**

A full metal firewall fabricated from magnetic steel and/or aluminum must encompass the driver's compartment from front-to-rear, on both sides and floor boards.

The driver's seat must be a high back aluminum seat, designed specifically for racing, located on the left side of the car and mounted per the manufacturer's instructions securely to the frame.

The seat design should be one from a current manufacturer and/or recommended to include the full containment design. Installation of the full containment seat should follow the manufacturer's instructions.

All cars must be equipped with a quick-release-type steering wheel that is a full circle.

The driver compartment must have a starting switch and/or button within reach of the driver.

A clearly labeled electrical on/off 'kill' switch must be within reach of the driver.

A clearly marked fuel shut off valve, labeled On and Off, must be mounted within reach of the driver. It must be labeled with the word(s) "Fuel Shut Off". Refer to the drawing in the drawing section of this rule book.

Mirrors of any-type will not be permitted.

Radios and/or electronic and/or data communication devices will not be permitted.

Any edge and/or sheet metal end in and around the driver compartment must be protected with trim and/or beading and rounded. Sharp and protruding edges will not be permitted.

A substantial rock guard with a minimum of three (3) additional roll bars must be mounted in front of the driver. The rock guard must be made from wire screen. Windshield screens must be a minimum of .090-inches and must be securely fastened. Fuel and/or power steering lines and/or fittings running through the driver's compartment must be made from an approved braided type of line. High pressure lines and/or fittings and/or hot fluid lines running through the driver's compartment must be encased and/or must have a shield.

A fully charged fire extinguisher meeting SFI 167.1 specifications with an activation push and/or pull knob within reach of the driver is highly recommended.

### **SEAT LOCATION**

Seat and location must be in center of car. Offset mounting not permitted

Bottom rear of seat must be a maximum of 16 inches from centerline of rear axle

### **REAR SPOILER**

A one piece, clear lexan spoiler with a maximum height of 5"-inches from the rear deck will be permitted. Lettering and/or decals will not be permitted.

The rear spoiler must be non-adjustable from the cockpit and/or during racing conditions. Hinges, adjuster(s), slides and/or another adjusting type device will not be permitted.

Metal gurney and/or table and/or flanges and/or lips will not be permitted.

A brake and/or bend on the top of the Lexan spoiler will be permitted for reinforcement.

The maximum overall height of the spoiler when measured from the ground must not exceed 50"-inches.

A maximum four (4) of vertical supports (a maximum of 2"-inches in vertical height and 10"-inches in length) for the purpose of

fastening the spoiler to the rear deck will be permitted.

Rear panhard bar adjustment devices will not be permitted in the driver compartment. Any rear panhard adjustments that have a knob and/or an adjustment device outside of the cockpit must be wired in a fixed position for competition. Adjustable panhard devices of any type will not be permitted during competition.

### **SHOCKS**

Pro Shocks – WB and SS Series DIRTcar Sportsman Modified      Bilstein – AK and SG/SM Series

Bilstein – SL/SZ Series

RUSH – 162-55 or 165-55 (Note each part # is identical valving)

RUSH – 162-90

RUSH – 208-72

FASTRAK will be adding a specific shock at a later date

One shock per wheel

No alterations of sealed shocks allowed

Buy rule: \$200 per shock

Shock covers permitted but must be removed for tech inspection pre race and post race

Driver not permitting shock to be “bought” will be considered illegal and all shock penalties apply

Sealed shocks may not be tampered with. Subject to inspection and testing at any time.

If shock is dyno tested by manufacturer and found to have been tampered with shock will be destroyed.

Illegal shock penalty 1<sup>st</sup> offense \$500, loss of points and all monies, 2<sup>nd</sup> offense \$2500 fine and banned for 365 days.

### **SPRINGS**

Torsion bar and/or coil over spring suspension only. No cantalever suspension permitted

Coil springs must be manufactured from magnetic steel.

Stacked springs will not be permitted.

Only one spring per shock; no dual, concentric

Traditional take up springs will be permitted providing they carry no functioning rate (must be able to compress by hand)

A progressive rated spring will be permitted.

Bump stops permitted - Spring bumps permitted. No pneumatic or hydraulic bump stops permitted.

No coil spring inserts

Preload adjustments only by mechanical adjusting nuts on shock body

No spring adjusters by hydraulic or electronics permitted

### **BRAKES**

Must have 4 wheel working brakes

Magnetic material only. Will be verified by magnet

Live rear axles one inboard and one outboard assembly permitted

Brake bias bar legal

RF manual cut off only

### **TIRES**

Tires to be announced

### **WHEELS**

Aluminum or steel wheels only

No bleeders of any type

Maximum wheel width of 14 inches – 15 inch wheels only

Bead locks are legal but on outside of wheel only

Wheel spacers are legal. Aluminum only

Wheel Covers must be plastic and have no less than 3 “working” fasteners

Foam inserts are legal

## **BUMPERS**

All bumpers, side bars, nerf bars and bracing must be made from a minimum 1-1/2” diameter round ,095”-inch thick magnetic steel tubing only unless otherwise specified.

All edges and/or corners on bumpers and side bars/nerf bars must be rounded. Sharp edges will not be permitted

Rear bumper and side bars may not extend part outside of tire sidewalls on either side

### **FRONT BUMPER**

Front bumpers may be made from a minimum 1-1/4” diameter round ,095”-inch thick magnetic steel tubing.

Front bumper must consist of two (2) horizontal rails; an upper and a lower and a minimum of two (2) vertical braces, equally spaced welded between the (2) horizontal rails. The horizontal rails must be fastened to the frame with four (4) sockets or supports. The front bumper must remain exposed without covering or any sheet metal fabrication surrounding it.

The four (4) tubes that support the bumper from the four (4) frame sockets must be horizontal. These rails must be a minimum and a maximum of 12”-inches apart when measured from the top to the bottom and maintain that measurement for a minimum width of 24”-inches and a maximum width of 30”-inches. The front bumper must also have an 18”-inch center when measured from the ground up to the middle of the bumper. of 6”-inches

The maximum the front bumper may extend from the centerline of the front axle is 24”-inches and a minimum of 20”-inches.

The front surface of the bumper must remain flat, parallel and perpendicular with the front of the nose piece for the full width of the bumper. V-shaped and/or any other type of shaped bumpers will not be permitted.

The end bracing tube of the front bumper must be fabricated on an angle in such a way as to prevent the bumper of another car becoming interlocked. Please refer to the drawing at the back of this rule book.

### **REAR BUMPER**

The rear bumper must consist of two (2) rails, an upper and lower, which must have four (4) sockets and horizontal support bars positively attaching it to the frame. The upper and lower rails must also be a minimum of 10”-inches apart and a maximum of 16”- inches apart from the top to the bottom and maintain that measurement for a minimum width of the 64”-inches and a maximum of 86”-inches.

The rear bumper must have an 18”-inch center when measured from the ground to the middle of the bumper.

The maximum the rear bumper may extend back when measured from the centerline of the rear axle is 52”-inches.

The rear surface of the bumper must remain flat and parallel with the back of the rear quarter panel for the full width of the bumper. V-shaped and/or any other type of shaped bumpers will not be permitted.

### **RUB RAILS**

Solid and/or bars with ballast added will not be permitted.

The rub rails must be exposed and outside the body panels. The left side rub rail may extend a maximum of 2”-inches outside the left rear tire sidewall.

The rub rails must be bent with a gentle radius at a 90-degree angle and must protrude a minimum of 6”-inches back in past the body.

The rub rails must be a minimum of 50”-inches long from socket-to-socket. Rub rails on the right side must only be a single bar piece of tubing from front-to-rear. Rub rails that have additional rails parallel to the main rail will not be permitted. Double rub rails will be allowed on left side only.

### **FRONT END**

The front axle must be a straight, one-piece axle manufactured from magnetic steel tubing. No camber adjustable front axles.

Split axles and/or dropped axles and/or independent front suspension(s) will not be permitted.

All brackets on the front axle must be welded and/or bolted. Bird cages and/or sliders will not be permitted.

Front spindles must be non camber adjustable.

Bearing shafts that are made of steel are recommended.

The chassis may be offset a maximum of 4”-inches from the center of the inside tire width measured from the inside of the left

front tire to the inside of the right front tire at axle height. Refer to the drawing in the back of this rule book regarding front and rear end offset details.

The front wheels and tires must remain fully exposed. Fenders and/or air deflection devices of any type will not be permitted.

### **SUSPENSION COMPONENTS**

Independent front and/or rear suspensions will not be permitted.

A-Frames and/or ball joints will not be permitted for steering axis (kingpin only).

Four wheel steering, actuated by the steering wheel and/or of any type will not be permitted.

All suspension systems and designs must be mechanical. Hydraulic, pneumatic (air), electronic, radio and/or computer assisted for adjustments and/or in-or-out of cockpit type suspensions and/or suspension adjustment systems will not be permitted.

Traction control of any type, including within the braking system is not permitted.

Only a single brake bias and single rear panhard adjustment will be permitted in the cockpit. Any other type of adjustment, will not be permitted in the cockpit.

Must be a conventional style approved spring rod. No hydraulic spring rods permitted. Spring rods allowed on right rear radius rods only. No externally mounted shocks attached to radius rod. No rubber biscuits allowed on left rear radius rod. Droop limiters on left rear suspension will NOT be permitted.

Only conventional-type aluminum bird cages currently being used are allowed. Maximum bracket thickness 1". No 3 or 4-bar rear suspension; no rear floating bird cages. Any new birdcage designs must be approved.

The only materials used to fabricate axle housing mounts (birdcages) that will be permitted is aluminum or magnetic mild steel. Axle housing mounts fabricated of exotic, heavy materials will not be permitted.

When fabricating axle housing mounts detail must be paid to functionality. The completed axle housing mounts, when comparing the right and the left side, must be as similar in design as possible.

No front or rear sway bar assemblies.

No left side panhard bar and No left side j-bar permitted.

No 5th coil or shock control torque arm.

AMB TRANSPONDER

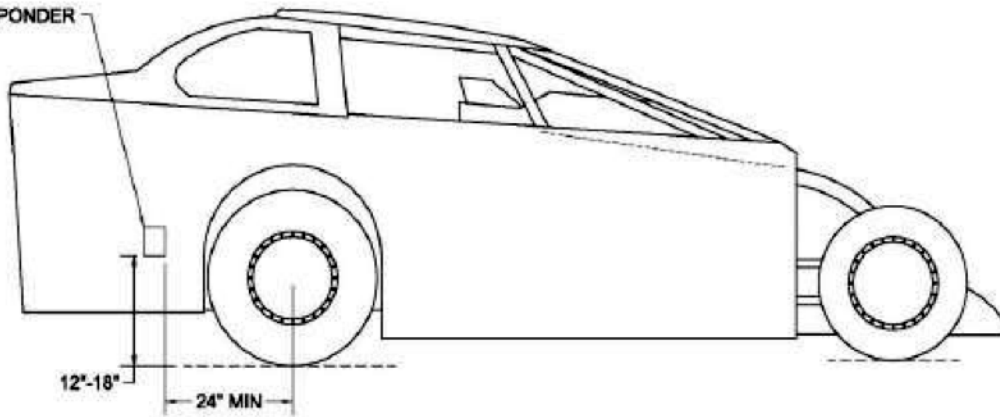

Transponders must be mounted on the inner right side sheet metal surrounding the fuel cell no less than 24" behind the rear axle centerline at a height of 12" to 18" from the ground. For optimum function, the transponder should be mounted as close to the ground as possible. Transponder must be mounted vertically with no obstruction between the transponder and the ground. It is recommended that a shield be installed in front of the transponder for protection from clay and debris. The shield can not be made of metal or carbon fiber. If using a rechargeable transponder with a mounting bracket, it is recommended that additional support like a tie wrap or similar be used. Do not rely solely on the cotter pin.

TRANSPONDER LOCATION

### Body Dimensions

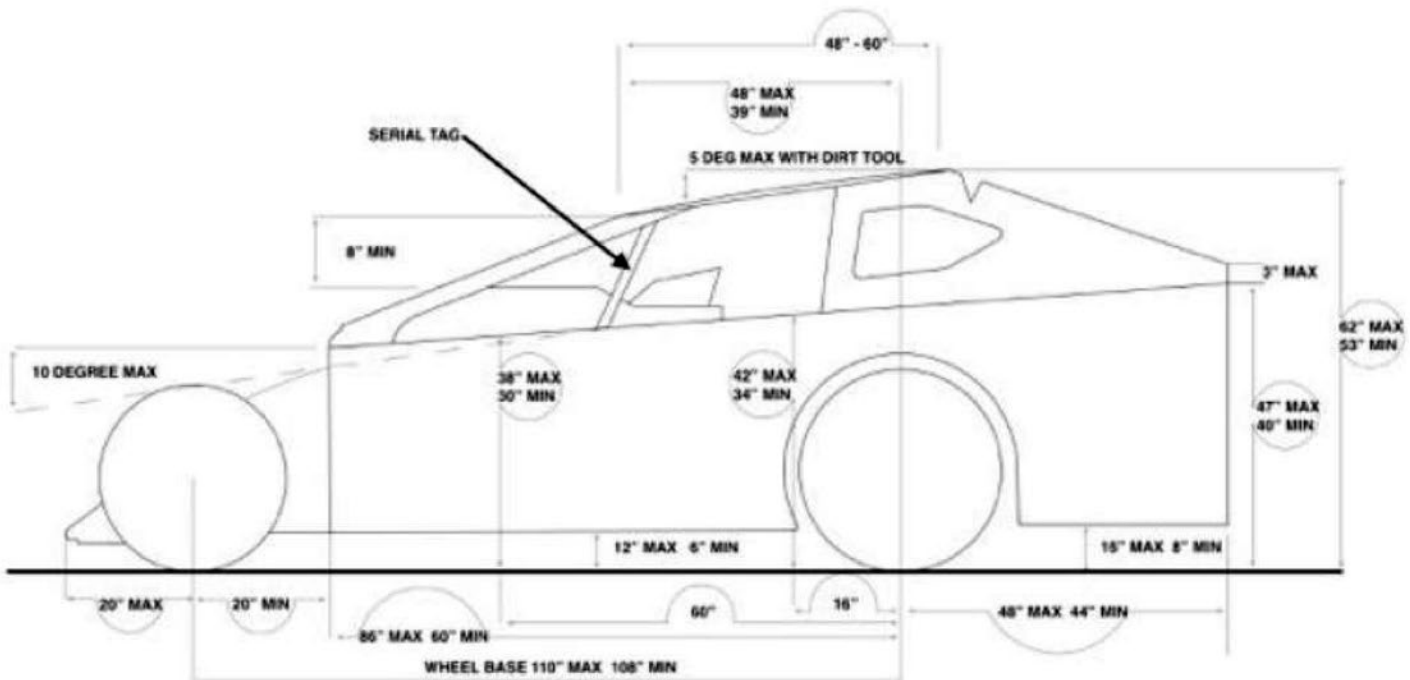

**Roof Profile:**

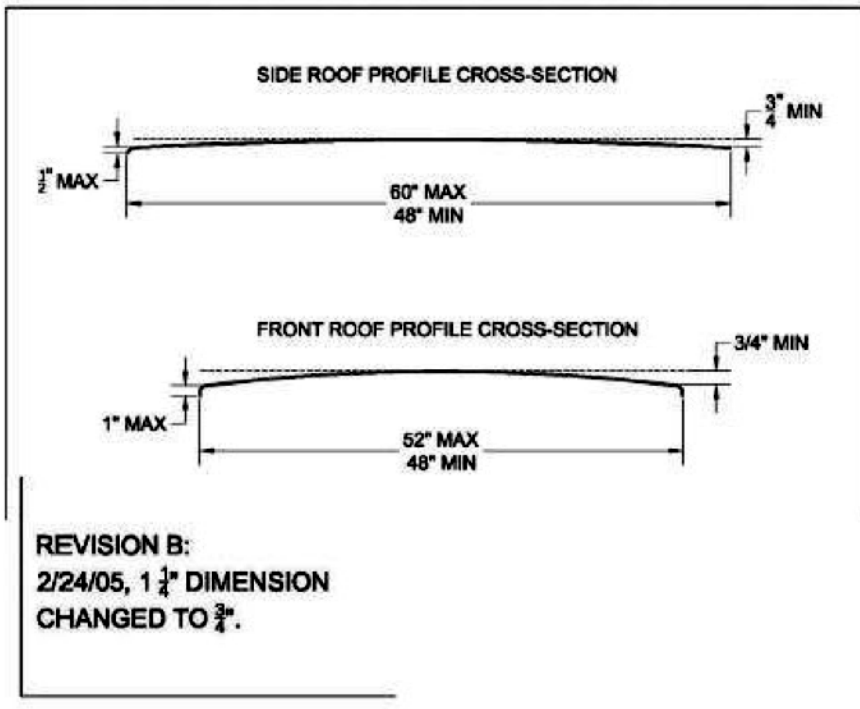



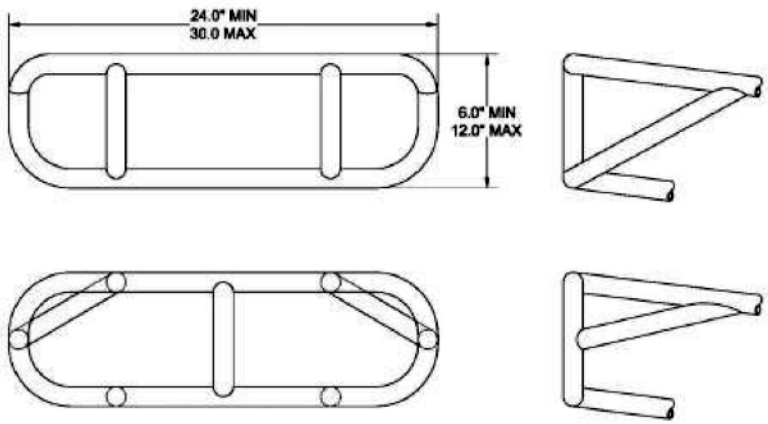

**NOTE:**  
 BUMPERS MUST BE CONSTRUCTED  
 OF 1 1/4" X 0.095 TUBING AND  
 MAINTAIN A HEIGHT OF 18"  
 MEASURED FROM THE GROUND TO  
 THE MIDDLE OF THE BUMPER

**Chassis Diagram:**

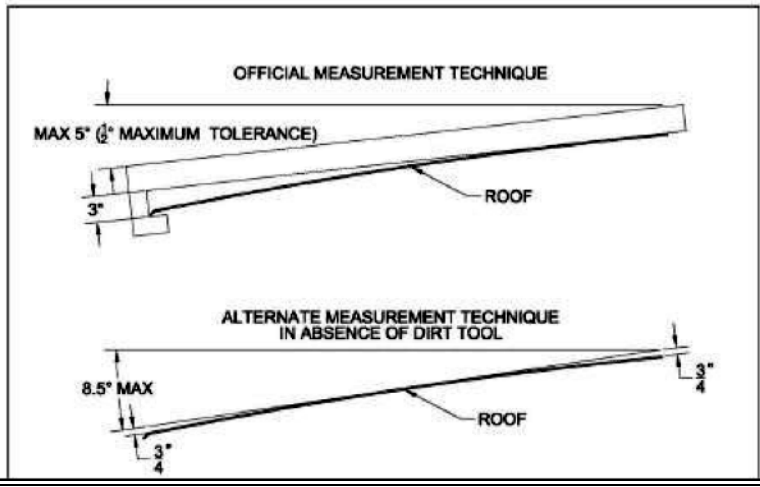
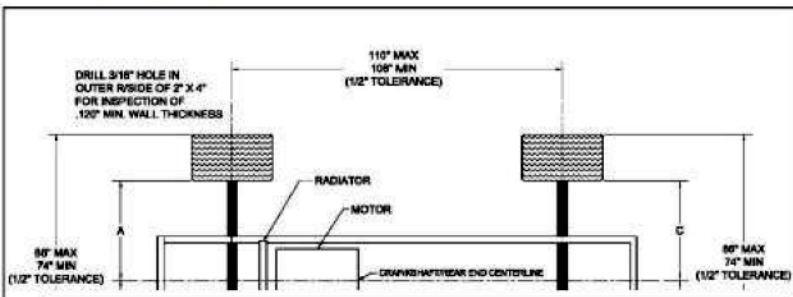

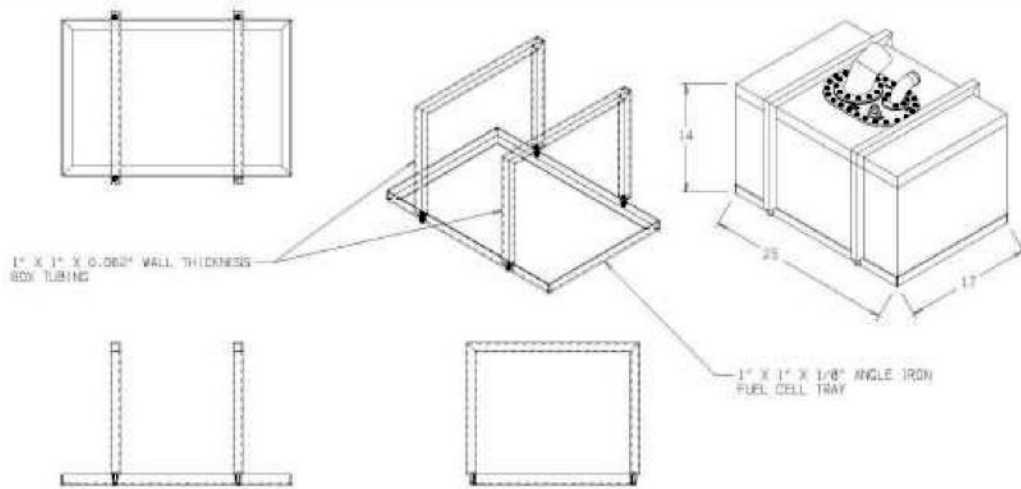

***Fuel Cell:***

